

YOKE | MULTIPURPOSE STRONGMAN KE | YOKE AND SQUAT STAND

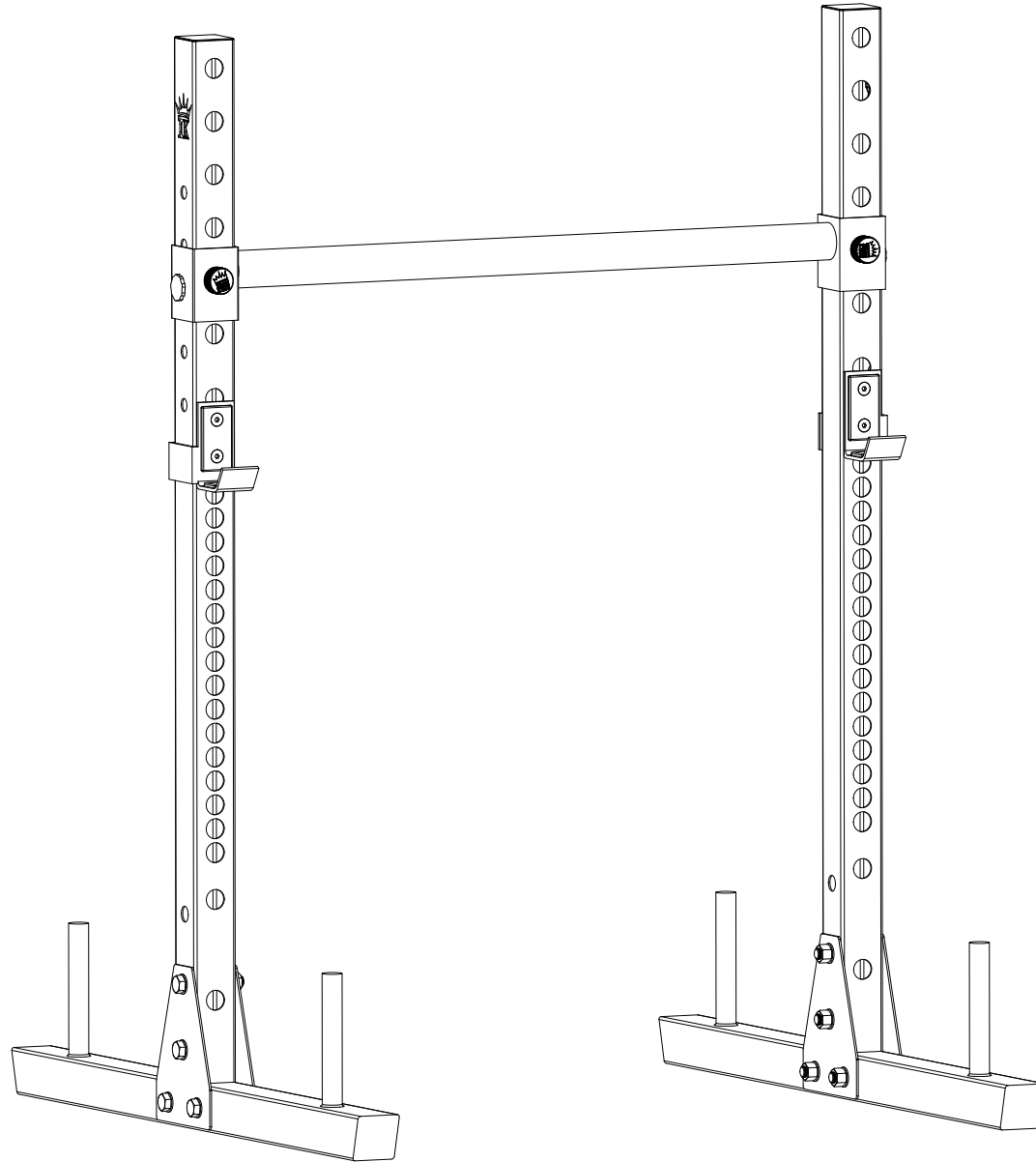

#trainincolour

YOKE | PRODUCT SPECIFICATION



WARNING

TO AVOID POSSIBLE HARM, READ AND FOLLOW THIS ADVICE AND THE FOLLOWING INSTRUCTIONS.

MISUSE OF THE EQUIPMENT OR INCORRECT ASSEMBLY MAY RESULT IN SERIOUS OR FATAL INJURY.

ENSURE THAT ALL PARTS ARE UNDAMAGED AND IN WORKING ORDER BEFORE ATTEMPTING TO USE THE PRODUCT.

ENSURE NUTS AND BOLTS ARE TIGHT AND THAT ALL PARTS ARE PLUMB BEFORE USE.

WE RECOMMEND A MINIMUM OF 2 PEOPLE FOR SAFE ASSEMBLY OF THE PRODUCT.

WEAR APPROPRIATE P.P.E. WHILE ASSEMBLING.

MAX TRAINING WEIGHT	400KG
PRODUCT WEIGHT	75KG
DIMENSIONS	1M x 1.2M x 1.8M
PRODUCT FOOTPRINT	1M x 1.2M

YOKE | PARTS LIST



TOOLING

19MM SPANNER

STEP LADDER

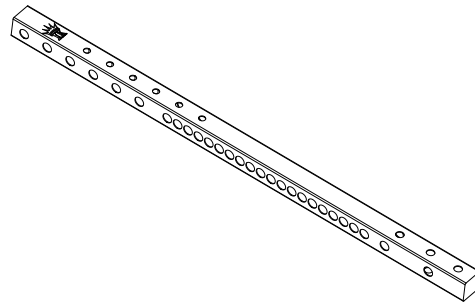

x2 UPRIGHTS [1]

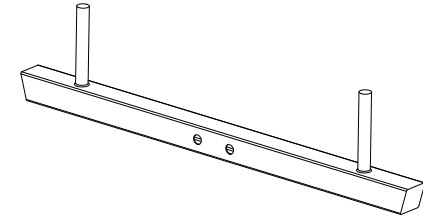

x2 BASE FEET [2]

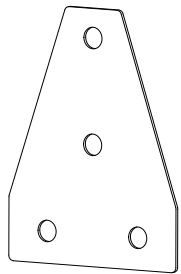

x4 BRACE PLATE [3]

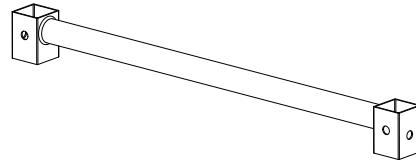

x1 BAR [4]

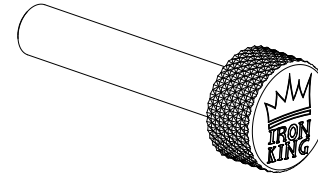

x2 IRON KING PIN [5]

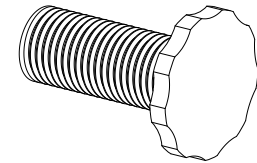

x2 SCREW [6]

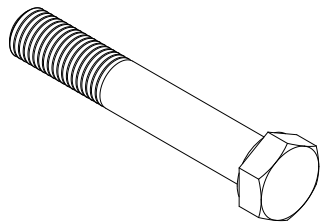

x8 M12 BOLT [7]

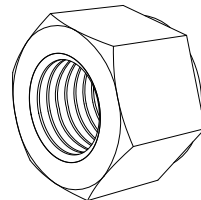

x8 M12 NUT [8]

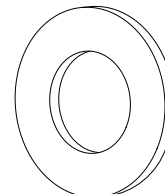

x16 M12 WASHER [9]

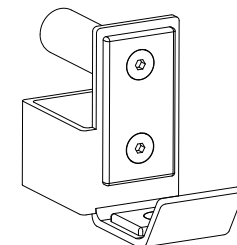

x2 'J' HOOKS [10]

STEP 1 | ASSEMBLY



LINE UP THE x4 BRACE PLATES [3] WITH THE BOTTOM TWO HOLES ON THE x2 UPRIGHTS [1] AND THE TWO CENTRAL HOLES ON THE x2 BASE FEET [2].

ENSURE THAT THE IRON KING LOGOS ARE AT THE TOP END AND FACING OUTWARD FROM THE RACK.

FASTEN TOGETHER USING x8 BOLTS [7], x8 NUTS [8] AND x16 WASHERS [9].

REQUIRED

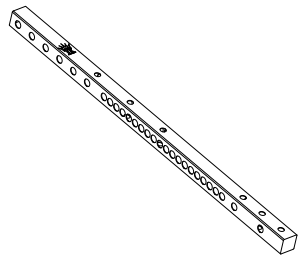

x2 [1]

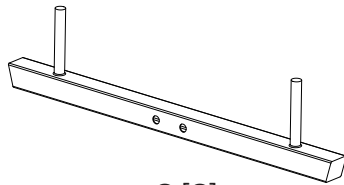

x2 [2]

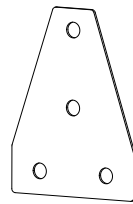

x4 [3]

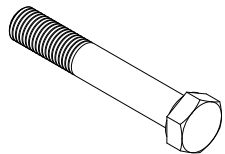

x8 [7]

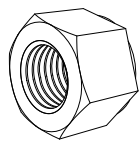

x8 [8]

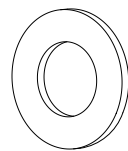

x16 [9]

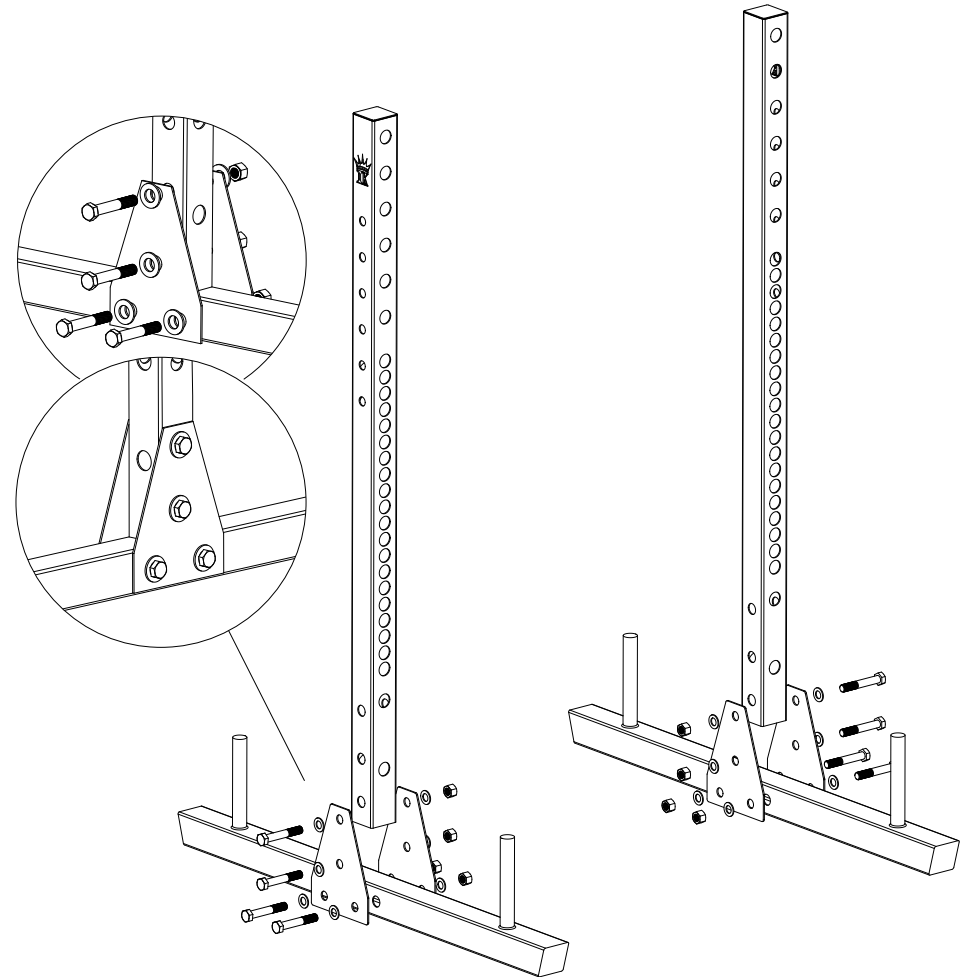

STEP 2 | ASSEMBLY

LIFT THE BAR [4] OVER THE TOP OF THE UPRIGHTS AND PLACE AT PREFERRED HEIGHT.

FIX USING THE x2 PINS [5] AT THE FRONT OF THE UPRIGHTS AND THE x2 SCREWS [6] AT THE SIDES OF THE UPRIGHTS.

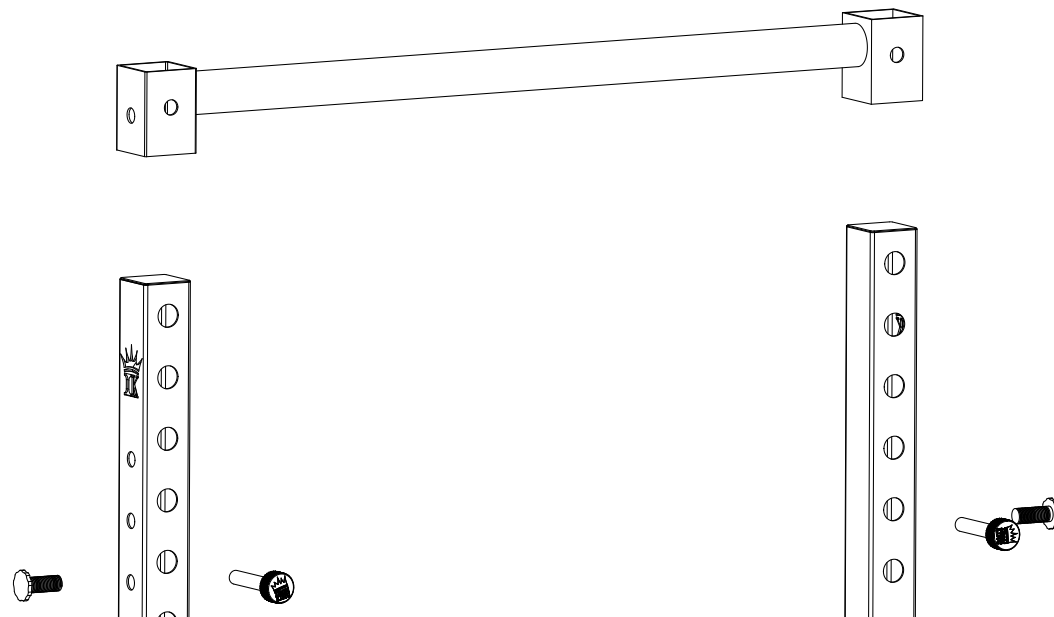

REQUIRED

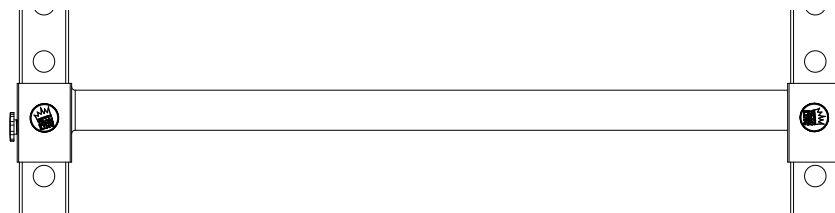
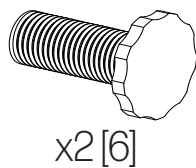
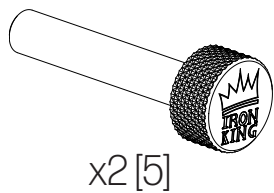
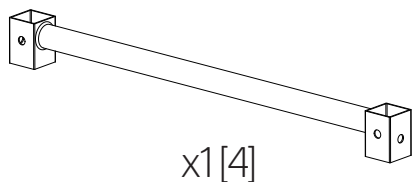

STEP 3 | ASSEMBLY

ATTACH THE x2 'J' HOOKS [10] TO THE UPRIGHTS.

HOLD THE 'J' HOOK UPRIGHT SO THAT IT LOOKS LIKE A 'J'. TURN THE 'J' HOOKS TO THE SIDE AND PLACE THE PIN INTO A HOLE ON THE FRONT OF THE RACK.

THE HOOK CAN NOW BE TURNED BACK UPRIGHT SO THAT IT SITS FLUSH WITH THE UPRIGHTS.

REPEAT THIS STEP FOR THE OTHER 'J' HOOK, PLACING IT IN THE EQUIVALENT HOLE.

REQUIRED

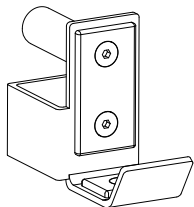

x2 [10]

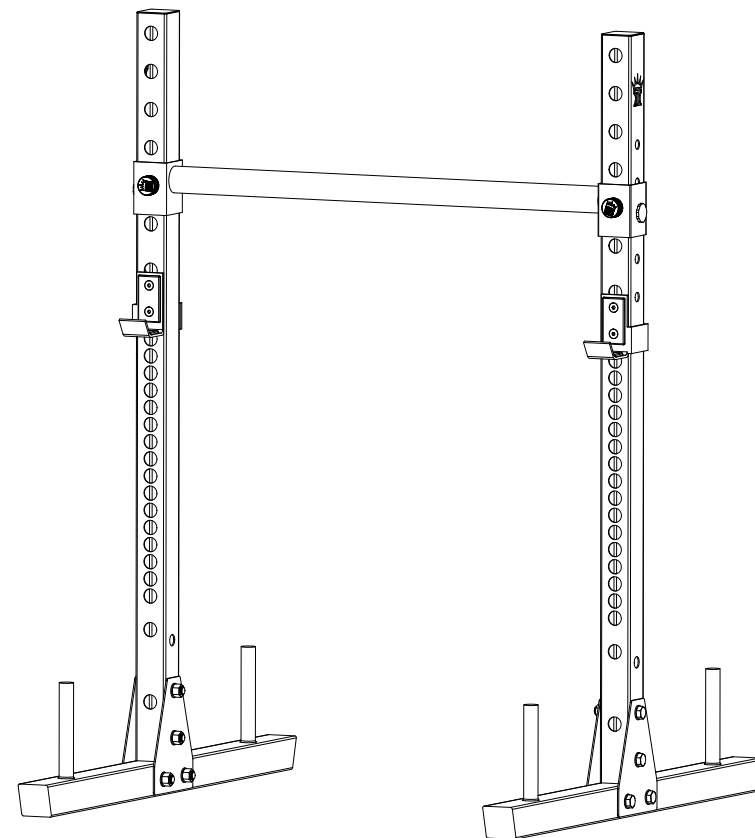
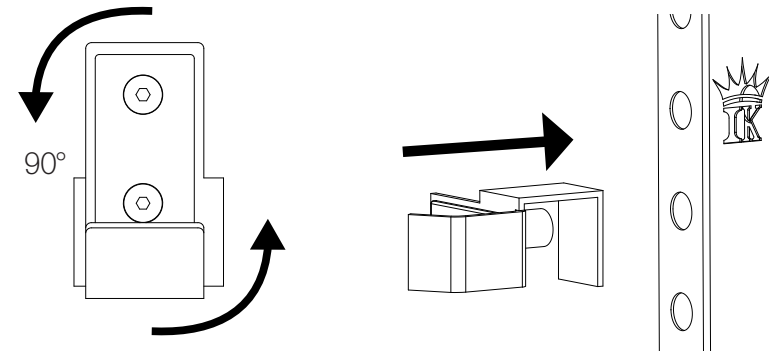

FOLLOW

 Iron King

 @iron_king_gym_equipment

#trainincolour

REVIEW

 Google
★★★★★ Reviews

 ★ Trustpilot
★★★★★

CONTACT

 www.ironking.uk.com

 sales@ironking.uk.com

 0121 326 9902